

Vero

QUICK START GUIDE

HARDWARE / Mount. Cables. Connect.

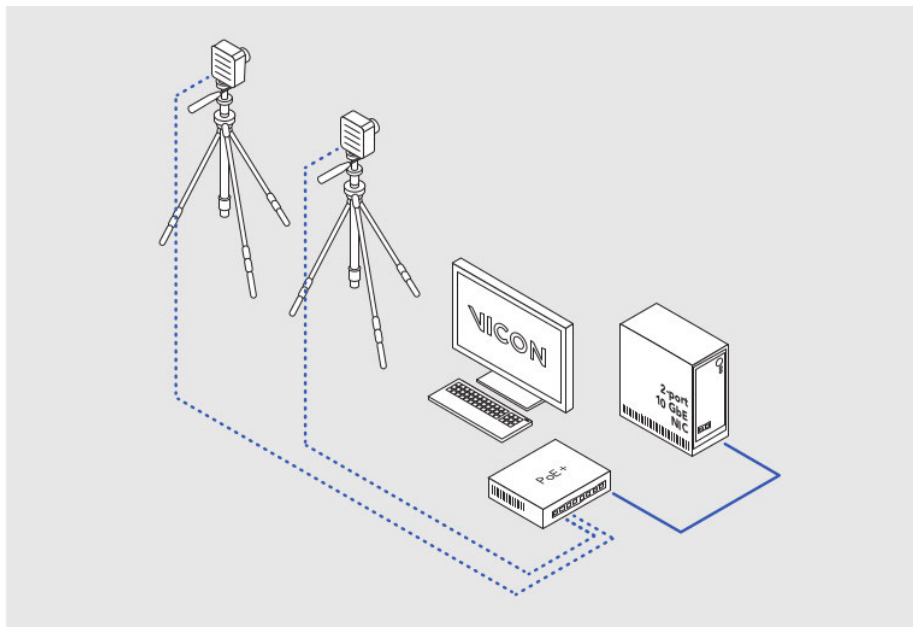

VOLUME / Visualize. Set up. Aim.

Lay out markers to define the desired volume.

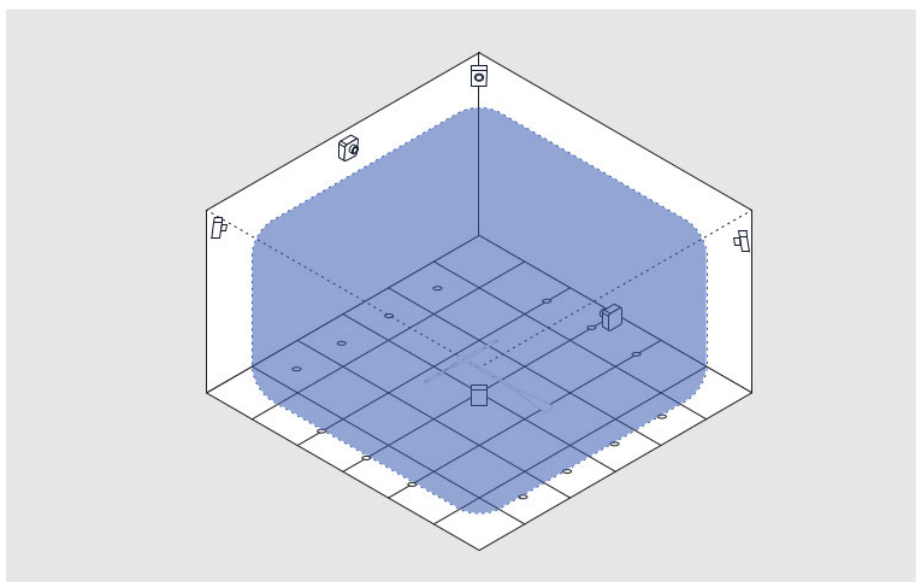

Point the cameras to provide roughly the required coverage.
You will be able to refine camera aiming later, using your Vicon software.

For easy system setup, use the Vicon Control app



See vicon.com/products/software/vicon-control.

<https://accessgudid.nlm.nih.gov/B548VICONVEROSYSTEM0>



Vero

QUICK START GUIDE

SOFTWARE / Download. Install. License.

- 1 www.vicon.com/downloads (supported from: Vicon Nexus 2.4, Vicon Tracker 3.3, Vicon Shogun 1.0)



- 2 Run SETUP.EXE.
- 3 Click Start, then Vicon Product Licensing.

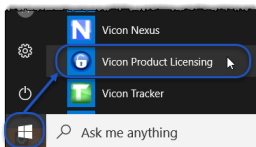

- 4 Request a license, save it to a suitable location and activate.

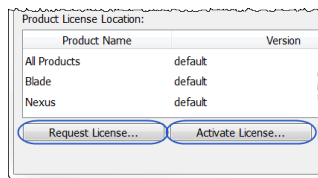

For details on installing and licensing, see your Vicon software documentation.

SYSTEM / Administrator. IP address. Adapter settings.

Important: Ensure you are logged on as Administrator.

- 1 Open the Network Connections window.
- 2 Right-click on the network port that connects to the PoE switch and click Properties.
- 3 In the Properties dialog box, click Configure and then the Advanced tab.
- 4 In the Settings list, ensure the values shown (in the images on the right and the first two columns on page 3) are selected, then click OK to close the dialog box.
- 5 Repeat step 2 to re-open the Properties dialog box.
- 6 Ensure only Internet Protocol Version 4 is checked (see page 3, last column) and click the Properties button.

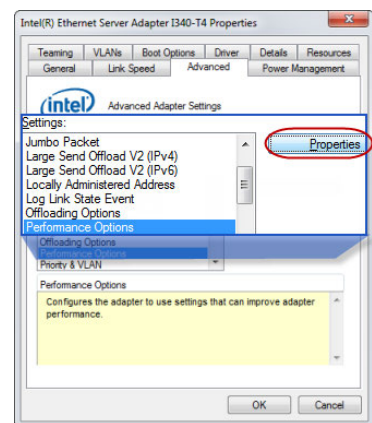
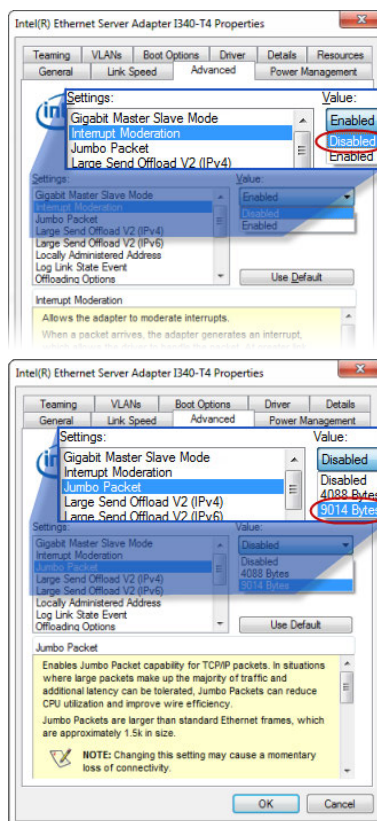

- 7 Specify the IP address 192.168.10.1 and subnet mask 255.255.255.0 (see page 3, last column) and click OK.

For detailed guidance on system setup, visit [Vicon system setup information](#) or download the Vicon PDF, *PC Setup for Vicon systems* from the same page.

SYSTEM (cont.) / Administrator. IP address. Adapter settings.

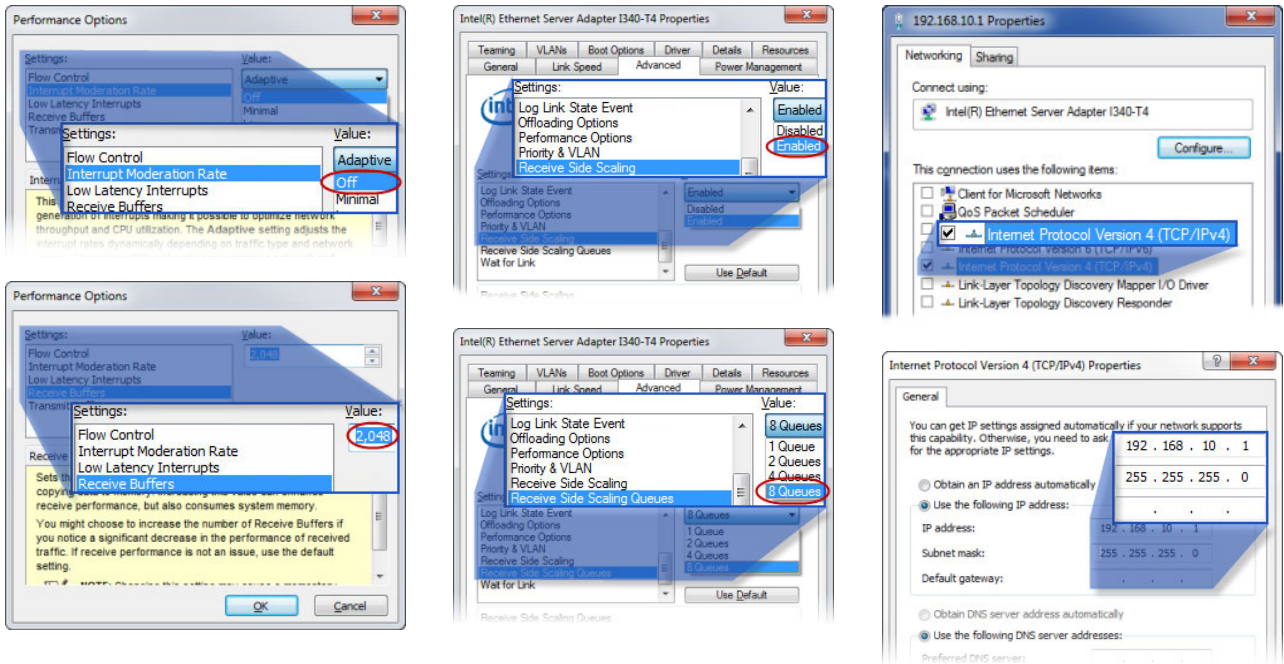

RUN / Start software. Unblock firewall. Connect.



1 After you start your Vicon software, ensure that it is not blocked by a firewall and that it shows the system is live.

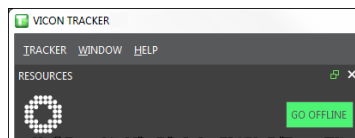
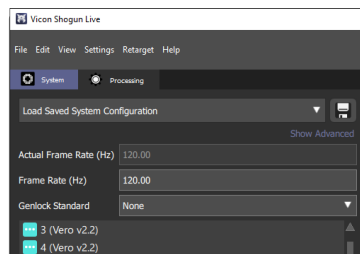
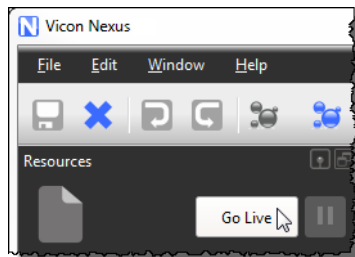
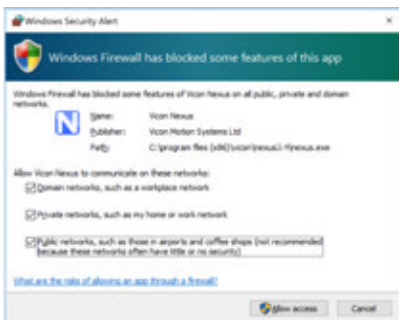

2 In the System Resources panel, Shift+click (or in Shogun, right-click in the System panel) to select all the cameras.

3 In the Properties pane, change Grayscale Mode to All.

4 In the System Resources panel (or in Shogun, System panel), select a camera.

5 In the View pane, change to Camera view.

You can now set the camera focus and aperture.

ADJUST / Zoom. Grayscale. Focus.

Focal length
W(ide) Focal length
T(elephoto)

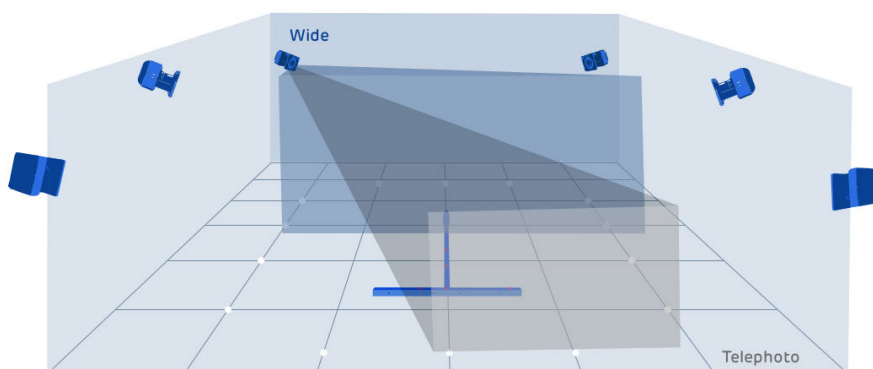

✗ Aperture too open:



✗ Aperture too closed:

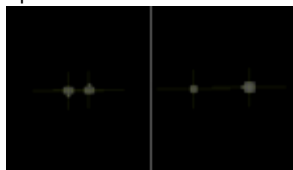

✗ Image out-of-focus:



Correct marker image:

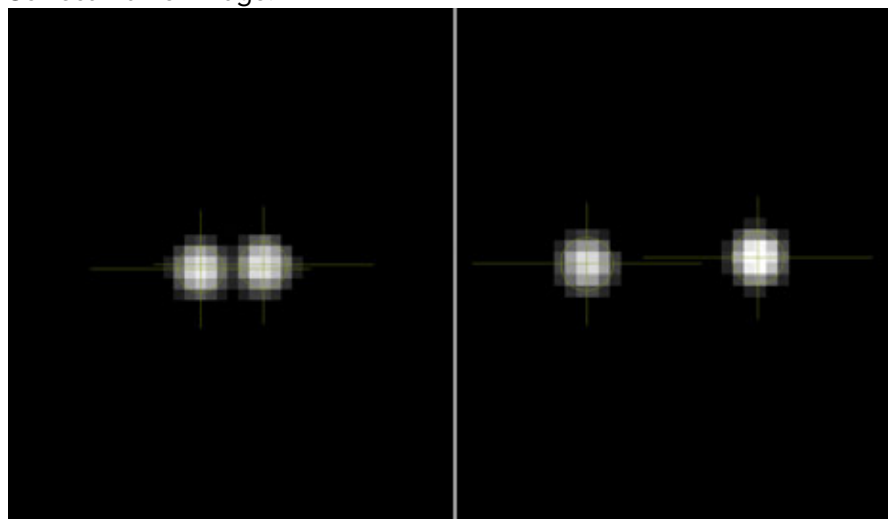

Markers touching

10 cm separation



The above example shows a correct marker image. The markers are not too small, with centers just off-white (not fully saturated) when viewed from the middle of the volume.



Warning

Under normal operation in elevated ambient conditions, the camera's heat sink temperature can exceed 56°C. During and after camera operation, *do not touch the heat sink for longer than 1 second.*



Important

Before you begin system calibration, select all cameras and change **Grayscale Mode** back to **Auto**. For more about calibration, see your Vicon software documentation.



About your Vicon camera packaging

The box in which your new Vero camera arrived has a foam insert that holds the camera. This insert prevents most damage that could be caused during shipping. We recommend that you retain this box as it provides the most convenient and safe way to ship your camera in future.

Vicon Vero regulatory and safety information

These topics provide information on how Vicon Vero complies with regulatory standards, including product recycling. The [certification](#) that Vero has achieved for meeting stated international standards.

- [Radio and television interference \(US and Canadian customers\)](#)
- [Environmental regulations \(EU customers\)](#)

Radio and television interference (US and Canadian customers)

This topic contains information concerning compliance with regulations of radio and television interference.

For United States of America customers

Federal Communications Commission (FCC) Part 15 Information

FC This equipment has been tested and found to comply with the limits for a Class A digital device, pursuant to Part 15 of the FCC Rules (CFR 47:Part 15:B:2013). These limits are designed to provide reasonable protection against harmful interference when the equipment is operated in a commercial environment. This equipment generates, uses, and can radiate radio frequency energy and, if not installed and used in accordance with the instruction manual, may cause harmful interference to radio communications. Operation of this equipment in a residential area is likely to cause harmful interference, in which case the user will be required to correct the interference at his own expense.

Properly shielded and grounded cables and connectors must be used in order to meet FCC emission limits. Vicon Motion Systems Ltd is not responsible for any radio or television interference caused by using other than recommended cables and connectors or by unauthorized changes or modifications to this equipment. Unauthorized changes or modifications could void the user's authority to operate the equipment.

This device complies with Part 15 of the FCC rules. Operation is subject to the following two conditions: (1) this device may not cause harmful interference, and (2) this device must accept any interference received, including interference that may cause undesired operation.

For Canadian customers

Conformity to the Canadian Interference-Causing Equipment Regulations

This Class A digital apparatus meets the requirements of the Canadian Interference-Causing Equipment Regulations ICES-003:2004.

Avis de conformité à la réglementation d'Industrie Canada

Cet appareil numérique de la classe A respecte toutes les exigences du Règlement sur le matériel brouilleur du Canada ICES-003:2004.

Environmental regulations (EU customers)

Restriction of the use of certain hazardous substances in electrical and electronic equipment – RoHS and recast (RoHS 2)

This equipment is fully RoHS- and RoHS 2- compliant. RoHS Directive 2002/95/EC provides that new electrical and electronic equipment put on the market for the first time from 1st July 2006 should not contain lead, cadmium, mercury, hexavalent chromium, polybrominated biphenyls (PBB), or polybrominated diphenyl ethers (PBDE). The European Union Directive [2011/65/EU](#) provides that new electrical and electronic equipment put on the market for the first time from 3rd January 2014 shall not contain more than permitted levels of lead, cadmium, mercury, hexavalent chromium, polybrominated biphenyls (PBB), or polybrominated diphenyl ethers (PBDE; PentaBDE, OctaBDE; DecaBDE), Mercury (Hg).

REACH Declaration of Conformity

Vicon Motion Systems Ltd is a manufacturer of electronic hardware. We are therefore considered a "downstream user" as far as the REACH document is concerned. Vicon Motion Systems Ltd is therefore not obligated to register with the European Agency for Chemicals 'ECHA'.

Products sold by Vicon Motion Systems Ltd are "articles" as defined in REACH (Article 3 Definitions). Moreover and under normal and reasonably foreseeable circumstances of application, the articles supplied shall not release any substance. For that, Vicon Motion Systems Ltd is neither obligatory for registration nor for the creation of material safety data sheets.

In order to assure our customers of the continual supply of reliable and safe products, we ensure that our suppliers fulfill all requirements regarding chemical substances and prepared materials.

Waste Electrical and Electronic Equipment (WEEE)

(Applicable in the European Union and other European countries with separate collection systems)



The use of the symbol as a marking on the equipment, accessories or literature indicates that this product and its electronic accessories (e.g. USB cable) may not be treated as household waste. By ensuring this product is disposed of correctly, you will help prevent potential negative consequences for the environment and human health, which could otherwise be caused by inappropriate waste handling of this product. Household users should contact either the retailer where they purchased this device, or their local government office, for details of where and how they can take these items for environmentally safe recycling. Business users should contact their supplier and check the terms and conditions of the purchasing contract. This device and its electronic accessories should not be mixed with other commercial waste for disposal.

Declaration of Conformity - Vicon Vero



DECLARATION OF CONFORMITY

Manufacturer: Vicon Motion Systems Ltd

Address:
6 Oxford Pioneer Park,
Yarnton,
Oxfordshire,
OX5 1QU,
United Kingdom

Certification: BS EN ISO 13485:2016 (MD 727611).
UKCA Certification: UKCA 769032
UKCA: 0086
Product: Vicon Vero System
GMDN: 35757 (Gait Analysis System).
Classification: Class I(m)
EMDN: Z122062503 (Kinematic Optoelectronic Motion Capture Analysis Systems using Passive Markers).

Vicon Motion Systems Ltd hereby declares under its sole authority that the product listed above meets the applicable Requirements of UK MDR 2002 (SI 2002 no.618, amended) part II Annex V section 3.2 in that the Quality Management System has been approved BSI Assurance UK Ltd an approved body of the United Kingdom (Reg No. 0086) for the manufacture and support of the aforementioned Class I (m) Medical Device. Product Configurations and Software Options overleaf detail the product configurations and software options that conform to the metrological requirements of the UK MDR 2002 (SI 2002 no.618, amended).

Vicon Motion Systems Ltd has tested and demonstrated that all products of its own manufacture meet:

Standards relating to Quality Management Systems.

BS EN ISO 13485:2016 (Medical Devices, Quality Management Systems, Requirements for Regulatory Purposes).

Standards relating to Risk Management.

BS EN ISO 14971:2019+A11:2021 (Medical Devices, Application of Risk Management to Medical Devices)

Standards relating to Software.

BS EN 62304:2006+A1:2015 & IEC 62304:2006/A1:2015 (Medical Device Software, Software Life-Cycle Processes).



Standards relating to EMC (Electromagnetic Compatibility).

EN 60601-1-2:2007 (Medical Electrical Equipment - General Requirements for Basic Safety and Essential Performance. Collateral Standard: Electromagnetic Disturbances, Requirements and Tests)

Standards relating to Product Safety.

EN 60601-1:2006+A12:2014 (Medical Electrical Equipment - General Requirements for Basic Safety and Essential Performance)

Directives.

Electromagnetic Compatibility to EMC Directive (2014/30/EU).

Electrical Safety to Low Voltage Directive (2014/35/EU).

Not for use in an operating theatre, anaesthetic gas, or oxygen-rich environments. Not for use where there is a risk of compromising the essential performance of medical electrical equipment. Not suitable for use in high magnetic flux, ionising radiation, sterile, or life- or safety-critical environments.

Note: The overall installed system classification is defined by the highest risk device connected which may include the connection of approved third-party equipment such as electro-myography apparatus by clients.

Product Configurations and Software Options:

Conformity of the Metrological Performance of Class 1 Products Manufactured in accordance with Medical Devices Regulation Part II, UK MDR 2002 (SI 2002 no. 618).

Measurement Criteria:

Supporting software Nexus 2.10 or later, Shogun 1.4 or later, Tracker 3.8 or later.

Using a minimum of four cameras, resolution of the distance between the centers of two static 14 mm spherical markers located within a volume no less than 4 m x 4 m x 1.5 m to within 1 mm Mean; 1 mm Standard Deviation; sample size no less than 1,000

Analogue Digital Conversion:

Resolution to ± 10 mV mean and ± 10 mV (1 Standard Deviation).

Synchronisation:

Difference within one video frame.

I, the undersigned, hereby declare that the Vicon Vero System product conforms to the above Requirements, Standards and has been tested prior to shipment and meets the metrological performance.

Signature: 

Name: Adam Frank Daniel Hunt

Title/Role: Head of Quality & Regulatory Compliance

Date: 17th of August 2023.

Contact Vicon:

Denver, CO
Vicon Denver
12650 E Arapahoe Rd
Suite 200, Centennial
CO 80112, USA
T: 303.799.8686
F: 303.799.8690
E: support@vicon.com

Los Angeles, CA
Vicon LA
3750 S. Robertson Boulevard
Suite 100, Culver City, Los Angeles
CA 90232, USA
T: 310.437.4499
E: support@vicon.com

Oxford, UK
Vicon Oxford
6 Oxford Pioneer Park
Yarnton, Oxfordshire
OX5 1QU, United Kingdom
T: +44.1865.261800
E: support@vicon.com

© Copyright 2023 Vicon Motion Systems. All rights reserved.

Vicon Motion Systems Limited reserves the right to make changes to information or specifications in this document without notice.



[Vicon trademarks](#)